

# Installation

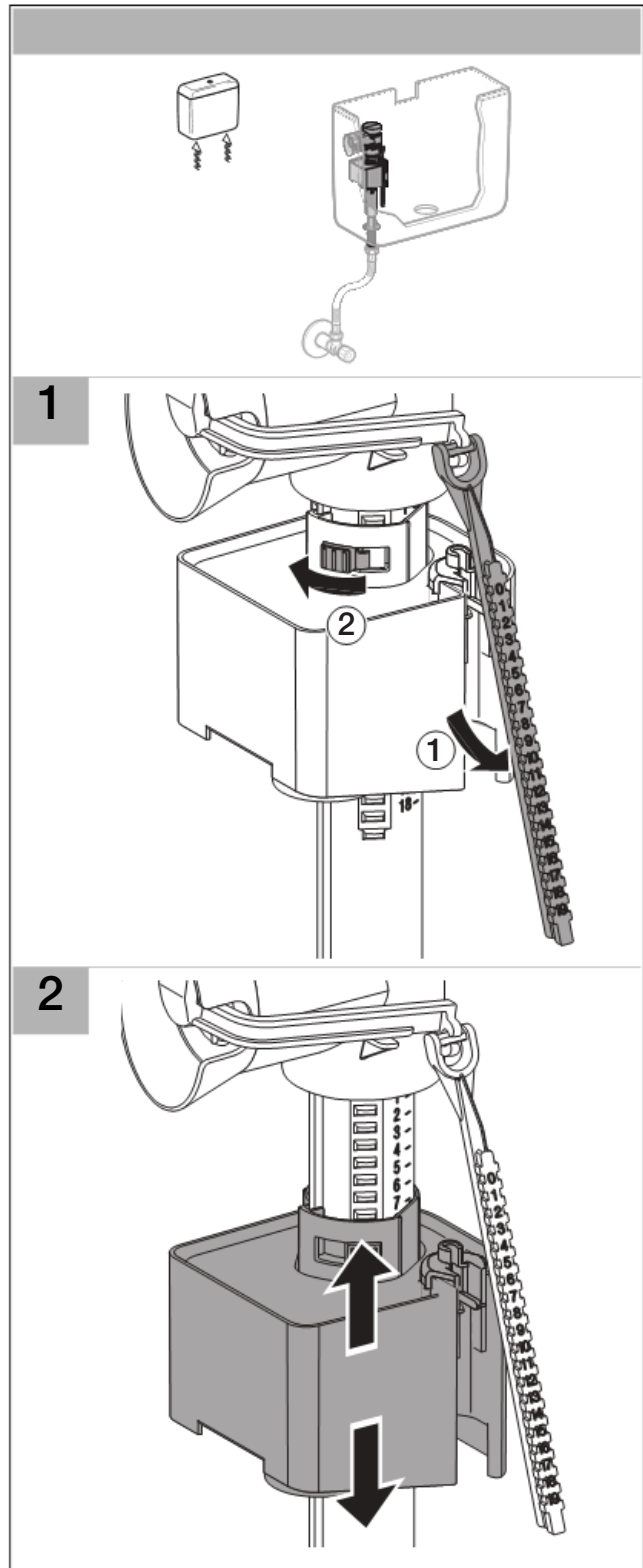

D31996-002&BDC © 03-2009

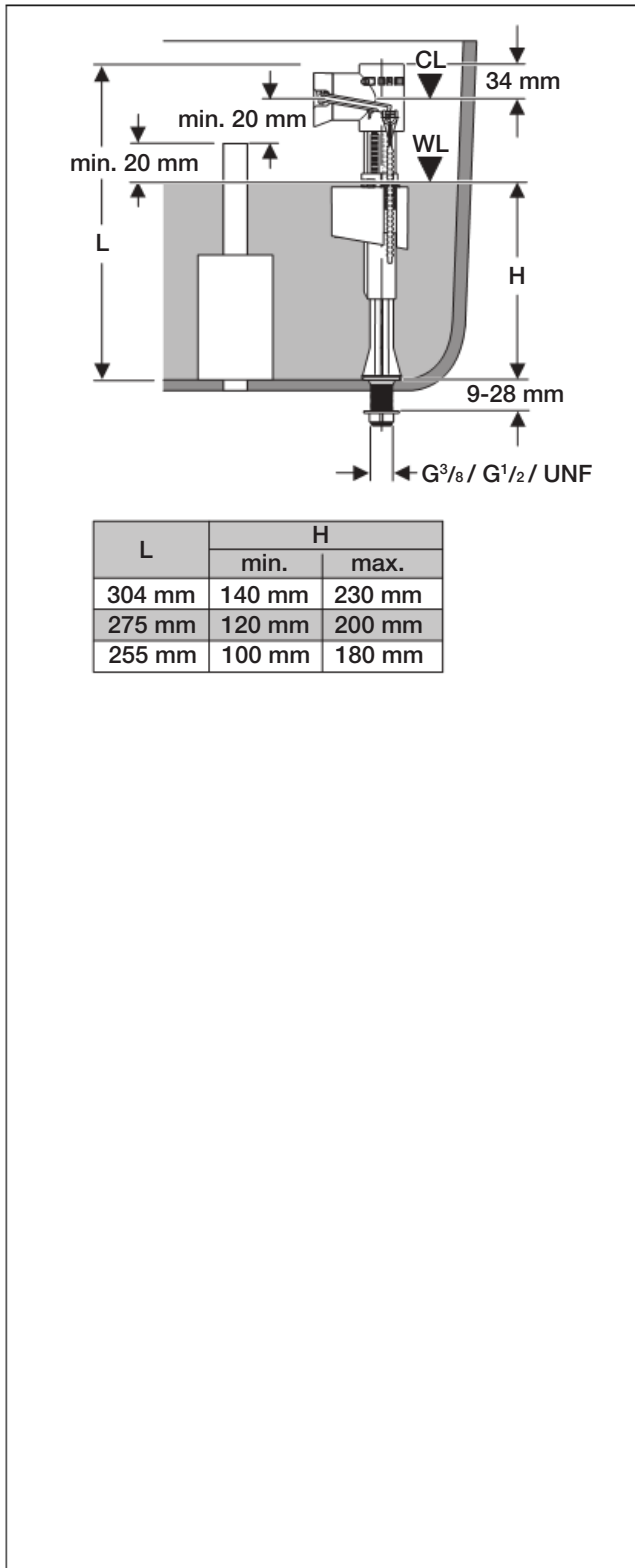
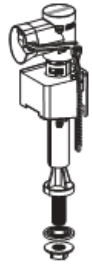
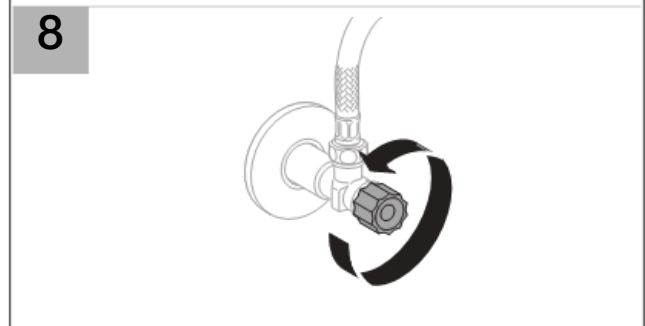
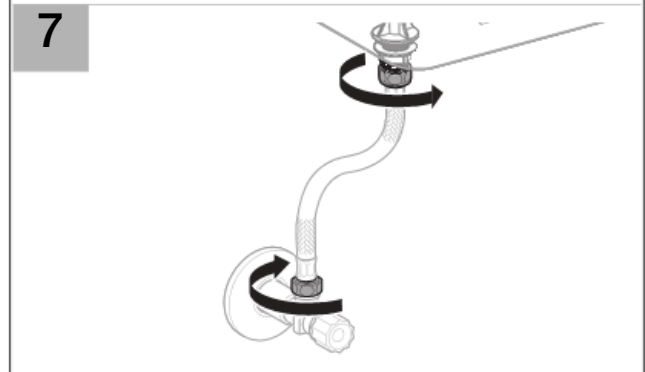
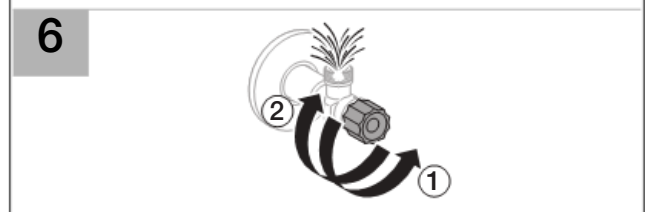
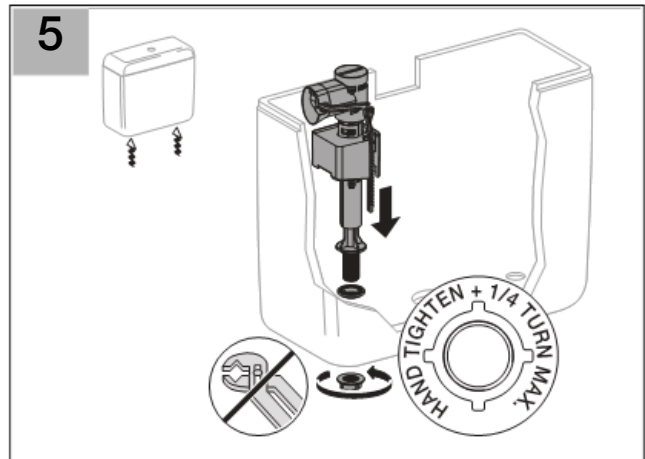
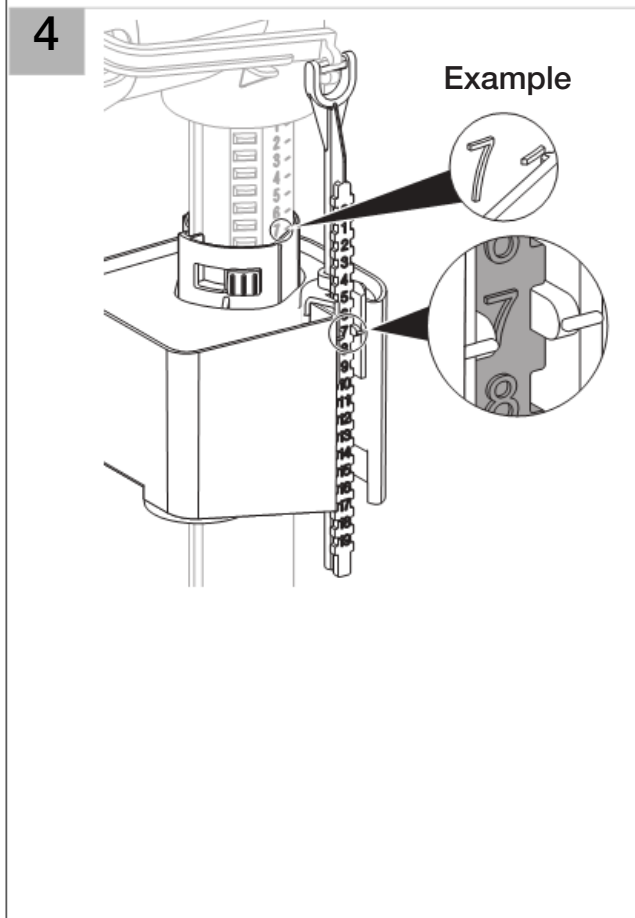
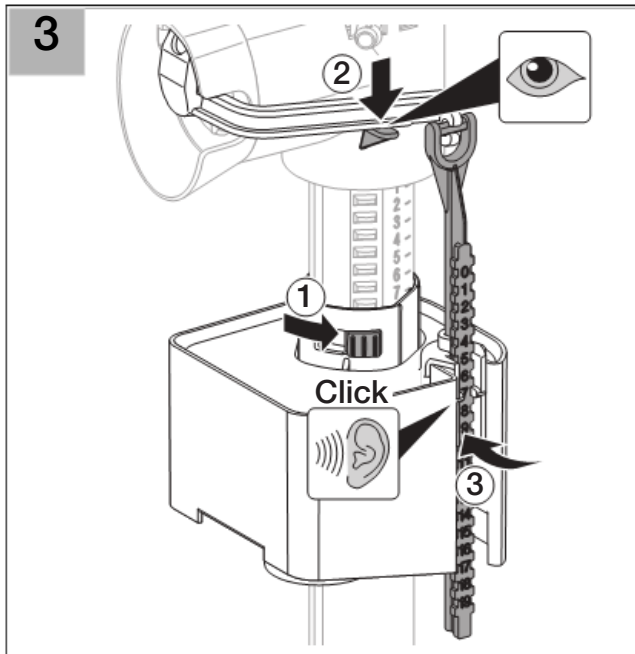

Geberit International AG  
 Schachenstrasse 77  
 CH-8645 Jona  
[www.geberit.com](http://www.geberit.com)  
[dokumentation@geberit.com](mailto:dokumentation@geberit.com)